

Savaria
Fixed Ceiling Lift

**OWNER'S
MANUAL**



IMPORTANT

Be sure to read this entire manual before using the Savaria Fixed Ceiling Lift. The information in this manual is important for the safety of the person being transferred and the operator, and for the proper use and maintenance of the device. Transfer always presents a potential risk and this manual provides important safety information that must be read and understood to help prevent injuries.

Unauthorized modifications to the device may affect its safety. Savaria Concord Lifts, Inc. will NOT be held responsible for any accidents, incidents or performance deficiencies that occur due to any unauthorized modification to the device. To avoid potential injury due to the use of inadequate parts, always use only Savaria replacement parts.

Regularly scheduled maintenance must be performed on your device by an Authorized Savaria Dealer to ensure safety and proper operation of the device. Refer to the *Maintenance* section in this manual.

NOTE

If a serious incident occurs in relation to the device should be reported to the manufacturer or distributor of the device. In the European community, the incident shall be reported as well to the competent authority of the Member State in which the user and/or patient is established.

Legal Manufacturer:

Savaria Concord Lifts, Inc.
2 Walker Drive
Brampton, Ontario L6T 5E1
Canada

European Representative:

Advena Ltd.
Tower Business Centre,
2nd Flr., Tower Street, Swatar,
BKR 4013 Malta

UK Responsible Person/Northern Ireland Authorised Representative:

Advena Ltd, Pure Offices, Plato Close,
Warwick. CV34 6WE UK

Australian Sponsor:

KD&A PTY LTD
286 Flinders St, Adelaide
South Australia, 5000

Copyright © 2023
Savaria Concord Lifts, Inc.
All rights reserved.

STANDARD NOTATIONS

The following notations may be used throughout this manual to emphasize important safety information, mechanical concerns, and other important information. Please review and follow all of these messages.



DANGER

Danger messages indicate an imminently hazardous situation, which, if not avoided, results in death or serious injury. All danger messages feature a standard ISO safety alert symbol followed by the signal word **DANGER** in capitalized black lettering on a red background.



WARNING

Warning messages indicate a potentially hazardous situation, which, if not avoided, could result in death or serious injury. All warning messages feature a standard ISO safety alert symbol followed by the signal word **WARNING** in capitalized black lettering on a dark yellow background.



CAUTION

Caution messages indicate a potentially hazardous situation, which, if not avoided, could result in minor injuries. All caution messages feature a standard ISO safety alert symbol followed by the signal word **CAUTION** in capitalized black lettering on a yellow background.

NOTE

Note messages provide information, such as reminders, general information about a previous statement, or additional guidelines that do not fit into the flow of the preceding text. All note messages include the signal word **NOTE** in capitalized white lettering on a blue background.

CONTENTS

1. OVERVIEW	6
Intended Use	6
Product Life	6
Using This Manual	6
2. SAFETY INSTRUCTIONS	7
To Ensure Safety	7
Battery and Charger Safety	8
Fire and Explosion Prevention	9
Electric Shock Prevention	9
3. DESCRIPTION	10
Exterior Views	10
Device Controls	11
Hand Control	13
Charger (M920001)	14
Symbols	15
4. SPECIFICATIONS	18
Dimensions	20
Compatibility	21
5. USING THE DEVICE	27
Before Transfer	27
Transferring the Person	27
Emergency Lowering	39
Emergency Brake	40
Charging the Battery	41
6. MAINTENANCE	43
Environmental Notice	43
Operator Maintenance Schedule	44
Dealer Maintenance Schedule	45
Inspection and Cleaning	46
Cleaning the Sling	47
7. TROUBLESHOOTING	48
8. ELECTROMAGNETIC COMPATIBILITY	49
Electromagnetic Compliance	49
Electromagnetic Immunity	50

1. OVERVIEW

Intended Use

The Fixed Ceiling Lift is designed for use by caregivers and health care professionals to lift and transfer a person in a homecare, assisted-living or hospital environment. Transfer must be performed by a qualified operator as described in this manual. **Do NOT use the device for any other purpose.**

Product Life

The device is designed for a useful life of 10 years after which time it must be replaced. To ensure this life span, you must perform the preventive maintenance as specified in the *Maintenance* section in this manual.



WARNING

Savaria Concord Lifts, Inc. cannot ensure complete safety for a device that has exceeded its useful life. Wear may cause failure of a part and lead to a patient fall.

The expected life for other parts such as slings, batteries, fuses, straps, and cords is dependent upon the proper care and use of the individual items. The items must be maintained as described in their accompanying documentation and in the *Maintenance* section in this manual.

Using This Manual

To ensure safe operation of the device, read this entire manual carefully, especially the *Safety Instructions*, before installing, using or maintaining the device. Failure to comply with all WARNINGS in this manual may result in injury. If there is anything you don't understand, contact your Authorized Savaria Dealer for further details.

Keep this manual with the device and ensure all operators are fully trained in the use of the device as described in this manual.

2. SAFETY INSTRUCTIONS

Keep these *Safety Instructions* with the device at all times. Read this entire manual before installing, using or maintaining the device.



WARNING

Do NOT use the device for any purpose other than to transfer a person. To ensure safety of the person being transferred and the operator, follow all Safety Instructions.

Take the necessary precautions to avoid any risk of entanglement posed by the lifting strap, hand control cable and emergency stop cord.

To Ensure Safety

- The ceiling lift has a safe working load of 272 kg (600 lb), 200 kg (440 lb) or 130 kg (286 lb). If the maximum load differs between the ceiling lift or a ceiling lift accessory, then the lowest maximum load shall always be used. Refer to the nameplate tags for the Maximum Load allowed.
- The ceiling lift shall be installed in a track system with equal or greater capacity. Never install a ceiling lift into a track not having sufficient loading capacity.
- The ceiling lift must be installed by an Authorized Savaria Dealer.
- Ensure the ceiling lift is used only with a Savaria ceiling track system. If the track system is not from Savaria, ensure the track system is properly assessed by a competent authority for fit, function, and safety.
- The track system must be installed by a trained and Authorized Savaria Dealer.
- Operators must be fully trained before using the ceiling lift.
- Ensure the sling is intended for use with this ceiling lift and can handle the weight of the person. Ensure the sling is not damaged in any way and the sling straps are in good condition and attached properly.
- Check with a qualified health professional to ensure the person to be transferred has been deemed suitable for transfer.
- Take extra care with a person who is connected to electrodes, catheters or other medical devices to ensure safe transfer.

- Take care to avoid impact during transfer.
- Keep all components of the device clean and dry.
- Follow the transfer procedures provided in this manual.
- Perform the “Before each use” checks and actions specified in the *Operator Maintenance Schedule* before using the device.
- Ensure all checks and actions are performed at the frequency indicated in the *Maintenance* section in this manual.

Battery and Charger Safety



Contact your Authorized Savaria Dealer if you are unsure of any of the safety instructions provided below.

- Do NOT expose the battery or charger to water or any other liquid.
- To avoid injury, do NOT alter the battery in any way. Stop using the battery if any damage is noted.
- Do NOT charge the battery in an unventilated area and do not cover the charger.
- If the battery case cracks and the contents of the battery contact your skin or clothing, rinse immediately with plenty of water.
- If the contents of the battery contact your eyes, rinse immediately with plenty of water and seek medical attention.
- Inhalation of the contents of the battery can cause respiratory irritation. Provide fresh air and seek medical attention.
- For recycling or disposal of batteries, follow the rules according to the WEEE directive (Waste of Electronic and Electrical Equipment) as well as all local laws and regulations. If you do not follow these rules, the battery may explode, leak and cause personal injury.

Fire and Explosion Prevention

- Use only lithium ion batteries that are designed for use with the device.
- Use only the charger that is supplied with the device.
- Do NOT store batteries in an area with a temperature higher than 70 degrees C (158 degrees F).
- Do NOT store the battery in direct sunlight or near any heat source.
- Do NOT expose the battery or charger to flames.
- Do NOT use the charger in the presence of any flammable anaesthetic gases.
- Do NOT short circuit the battery terminals.
- Do NOT incinerate the battery.
- Do NOT puncture the battery or try to open/dismantle the battery.

Electric Shock Prevention

- Do NOT touch or use the device if you notice any exposed or damaged wires.
- Do NOT expose electrical parts of the device to water or moisture.
- Do NOT attempt to use the charger in an area that has a different voltage and frequency requirement other than that specified on the nameplate.
- Do NOT attempt any repairs to the device, battery or charger. Always contact your Authorized Savaria Dealer for service.

3. DESCRIPTION

Exterior Views

Figure 1



Front view



Bottom view



Side view

Device Controls

Figure 2

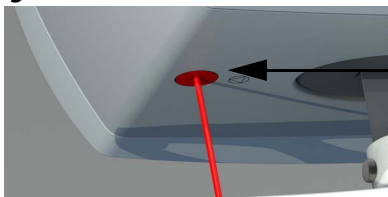

*On/Off Power Switch
(emergency stop cord)*







Light indicator and touchpad membrane

The touchpad membrane can be used to operate the ceiling lift. Use the UP and DOWN arrows to raise and lower the strap

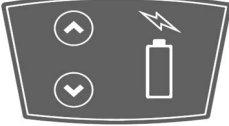
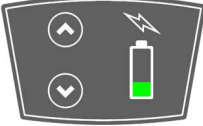
NOTE

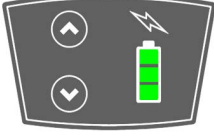
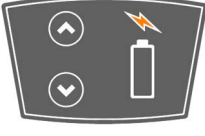
In order to see the battery level, the device must not be at the charging station nor in a powered CCR system (otherwise a full level will be shown).

	<p>Ceiling lift turned off or in sleep mode.</p> <p>NOTE: The device will automatically go into sleep mode after a few seconds of inactivity and the display will turn off. Pressing any button will wake the device.</p>
	<p>Battery level low</p> <p>NOTE: A blinking battery LED indicates the battery has reached its lowest level and needs to be recharged.</p>
	<p>Battery level medium</p>
	<p>Battery level high</p>
	<p>Battery Charging</p>
	<p>Battery overheated</p>

Hand Control

The hand control unit can be used to operate the ceiling lift. Use the UP and DOWN buttons to raise and lower the strap. For a device equipped with lateral motorization, use the LEFT and RIGHT buttons on the 4-button hand control to move the ceiling lift along the track.

Figure 3

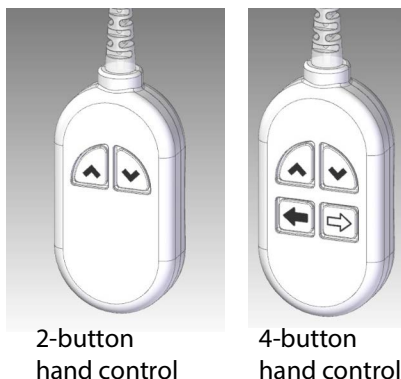

There is a magnet on the back of the hand control which allows you to attach it to the carry bar metallic tube or capacity plate on the carry bar when not in use.

Figure 4

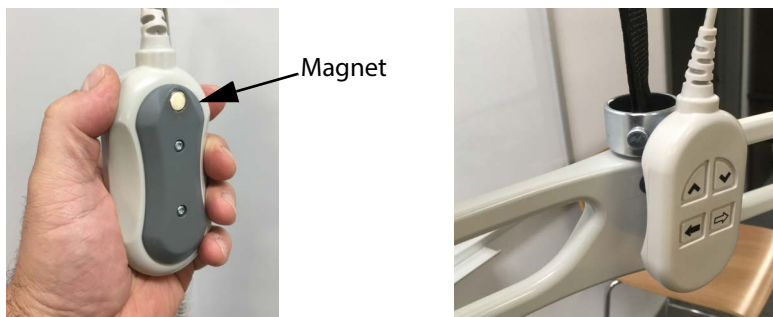

Charger (M920001)

The device is supplied with a battery charger. Please note the charger may slightly look different from the image shown below.

Figure 5

















LED Description







1. Green LED (solid): Charger is powered, device is fully charged or disconnected
2. Yellow, orange or red LED (depending on the charger version): Device is charging
3. Green LED (blinking/fading): erroneous plugging sequence (most likely to occur with M920001-X charger):
 - a. When this happens, user has to make sure that the charger is powered (plugged to the wall) prior to connect it to the device.

Symbols

The following chart illustrates the symbols that may be used on the nameplate, the packaging and the device.

Symbols on nameplate	
 YYYY-MM-DD	Indicates the medical device manufacturer. This symbol is accompanied by the address of the manufacturer and the date of manufacture. YYYY: Represents the year MM: Represents the month DD: Represents the day
	Indicates the authorized representative in the European Community. This symbol is accompanied by the address of the authorized representative.
	Indicates the UK Responsible Person. This symbol is accompanied by the address of the UK Responsible Person.
AUSTRALIAN SPONSOR:	Indicates the Australian Sponsor. This symbol is accompanied by the address of the Australian Sponsor.
	Indicates the manufacturer's catalogue number
	Indicates the manufacturer's serial number
	Indicates a medical device that needs to be protected from moisture
	Indicates the product complies with the medical device directive
	Indicates the product was certified by third-party "QPS"

	Indicates the product complies with the directive (RoHS)
	Indicates separate collection for waste of electrical and electronic equipment as per WEEE directive
	Caution
	Follow instructions for use
	Consult instructions for use
	Type BF protection against electrical shocks
MAX . LOAD :	Refers to the greatest permissible load that can be applied to the product
IPX₁X₂	Ingress Protection: X ₁ : Protection level against ingress of solid particles X ₂ : Protection level against ingress of liquids
 (01)10688503001006	Unique Device Identifier (UDI) carrier according to GS1.

	<p>Indicates the product is a medical device according to EU Medical Device Regulation 2017/745</p>
<p>Symbols on box label</p>	
	<p>Indicates the temperature limits to which the medical device can be safely exposed</p>
	<p>Indicates the range of humidity to which the medical device can be safely exposed</p>
	<p>Indicates the range of atmospheric pressure to which the medical device can be safely exposed</p>
<p>Symbols on device</p>	
	<p>Indicates the "Stop" button on the product</p>
	<p>Indicates heat warning when the yellow light turns on solid</p>
	<p>Indicates the location of the emergency lowering system on the product</p>

4. SPECIFICATIONS



WARNING

This equipment is not suitable in the presence of flammable anesthetic mixtures with air or oxygen, or with nitrous oxide.

Product	
Product Weight	Manual trolley version: 7.5 kg (16.5 lb) Motorized trolley version: 8.5 kg (18.7 lb)
Product Life	10 years
Safe Working Load (SWL)	272 kg (600 lb), 200 kg (440 lb) or 130 kg (286 lb)
Lifting Speed	5.5 cm/sec (2.2 in/sec) at 0 kg 5 cm/sec (2 in/sec) at 130 kg (286 lb) 4.5 cm/sec (1.8 in/sec) at 200 kg (440 lb) 4.0 cm/sec (1.6 in/sec) at 272 kg (600 lb)
Horizontal Speed (motorized trolley version only)	17 cm/sec (6.7 in/sec) 22 cm/sec (8.7 in/sec) - factory setting 30 cm/sec (11.8 in/sec)
Ingress Protection Rating	IP20
Noise Level	Maximum 54 dBA
Duty Cycle	Max 10%, 1 min continuous use
Medical Equipment Class	Class 1
Protection Class	Type BF
Power Source	
Battery	Battery type: Lithium Ion, 25.2V, 2500 mAh (replaceable)
Battery Capacity	Approximately 30 cycles of 61 cm (24 in) at 272 kg (600 lb) Approximately 45 cycles of 61 cm (24 in) at 200 kg (440 lb) Approximately 70 cycles of 61 cm (24 in) at 130 kg (286 lb) NOTE: When equipped with the constant charging system in the track, the number of cycles is limited to the duty cycle of the device and the charging time which translates to approximately 300 cycles per day at the maximum load.
Battery Charging	Full capacity in approximately 2 hours

Charger	
Input	100-240 VAC, 50-60Hz
Output	29.4 VDC, max 1A
Environmental Conditions: Operation	
Temperature	5 °C to 40 °C (41 °F to 104 °F)
Battery Charging Temperature	10 °C to 40 °C (50 °F to 104 °F)
Humidity	15 to 93%, non-condensing
Atmospheric Pressure	700 hPa to 1060 hPa
Environmental Conditions: Transport/Storage	
Temperature	-25 °C to 70 °C (-13 °F to 158 °F)
Humidity	0 to 93%, non-condensing
Atmospheric Pressure	500 hPa to 1060 hPa
Controls	
Device Controls	UP and DOWN buttons to raise and lower the strap
Hand Control	UP and DOWN buttons to raise and lower the strap LEFT and RIGHT buttons for lateral movement on motorized trolley models
Hand Control Operating Force	4 - 4.5N
Ingress Protection Rating (hand control)	IP67
On/Off Power Switch (emergency stop cord)	Allows to bring the device into operation and to safely terminate the operation. Also used as an emergency stop feature.
Certification	
IEC 60601-1:2005 + corr1:2006 + corr2:2007 + A1:2012 (Medical Electrical Equipment)	
IEC 60601-1-11:2015 (Homecare)	
ISO 10535:2021	
CAN/CSA Z10535.1:15 (Patient Lift)	
Compliance	
CE Marking per MDR (EU) 2017/745 (Medical Device)	
2006/42/EC (Machinery Directive)	
2015/863/EU (ROHS - 100% of components)	
2012/19/EU (WEEE)	

Dimensions

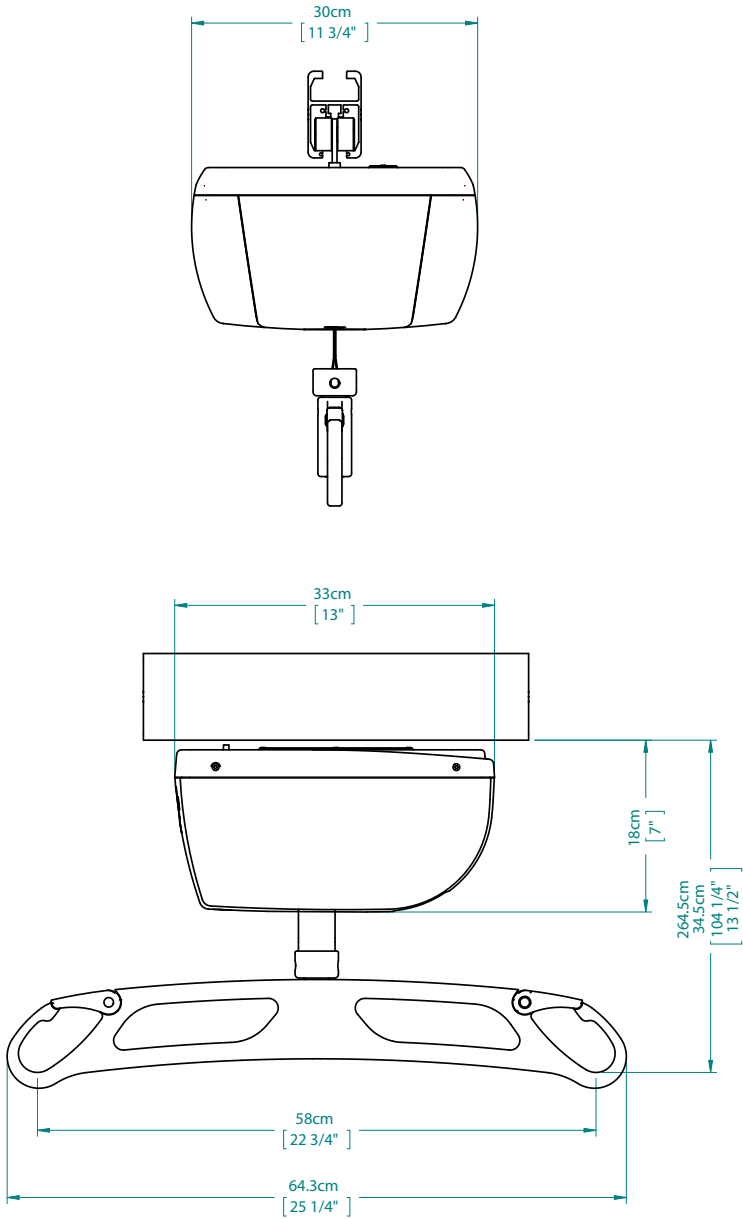

Compatibility

- Regular carry bar, M920660-xxx series

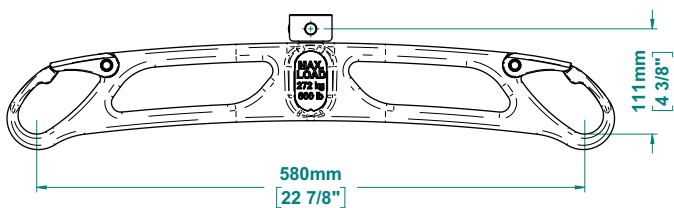
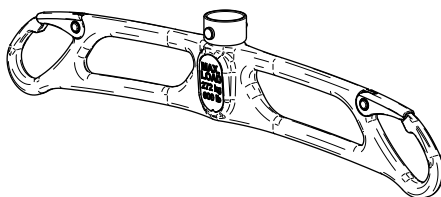

- Pediatric carry bar, M921340-xxx series

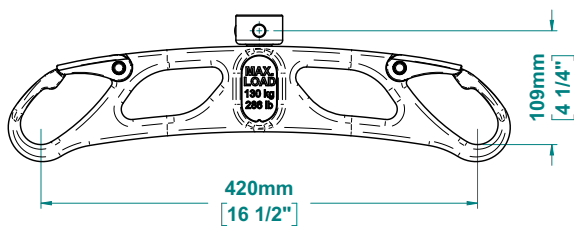
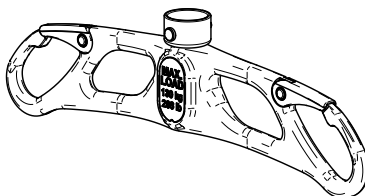

- 4-point carry bar, M921185-xxx series

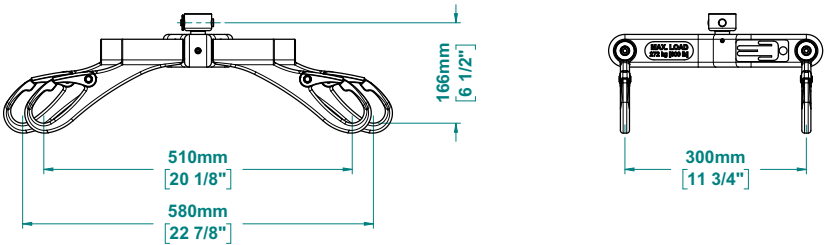
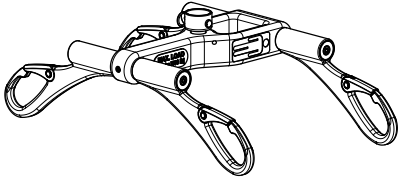

- Add-on carry bar kit, M921335-xxx series

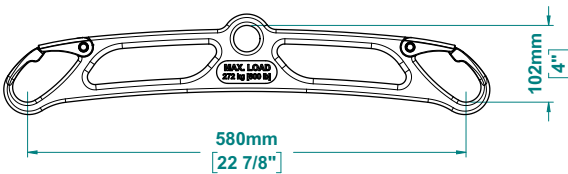
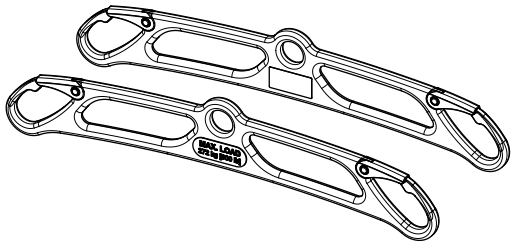

- Strap extension, M920370



- Hanging weighing scale, M921135

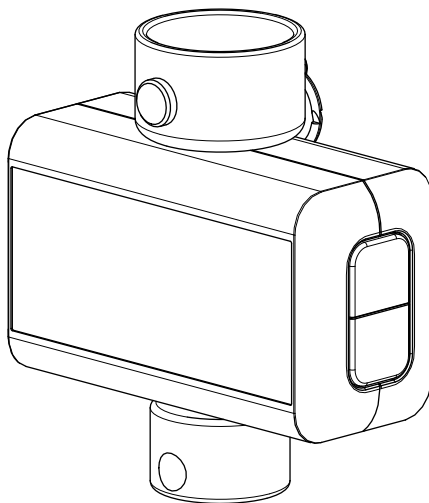



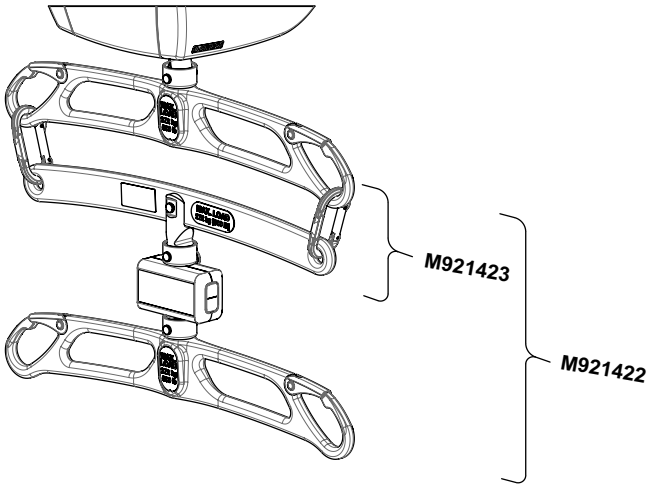

- Portable scale kit with carry bar, M921422
- Portable scale frame assy, M921423



- Slings

The following chart illustrates some of the different types of compatible slings. Note that each model is offered in various sizes, and comes in mesh or solid material.

<p>Universal without head support</p>  A grey fabric sling with four lifting points and two shoulder straps, laid flat on a wooden floor.	<p>Universal with adjustable head support</p>  A grey fabric sling with a central head support area and four lifting points, laid flat on a wooden floor.
<p>Hygienic</p>  A grey fabric sling with a black neck collar and four lifting points, laid flat on a wooden floor.	<p>Walking</p>  A grey fabric sling with a wide waistband, four lifting points, and two additional straps, laid flat on a wooden floor.
<p>Disposable</p>  A grey fabric sling with a mesh-like texture and four lifting points, laid flat on a wooden floor.	<p>Repositioning</p>  A large, rectangular grey fabric sheet with multiple lifting points along the edges, laid flat on a wooden floor.

NOTE

We recommend that you replace the sling 5 years after the manufacturing date specified on the sling label.

Guidelines to Select Proper Sling Size

Size	Weight
Extra Small (XS)	< 34 kg (< 75 lb)
Small (S)	34 to 57 kg (75 to 125 lb)
Medium (M)	57 to 114 kg (125 to 250 lb)
Large (L)	114 to 159 kg (250 to 350 lb)
Extra Large (XL)	159 to 204 kg (350 to 450 lb)
Extra Extra Large (XXL)	204 to 272 kg (450 to 600 lb)
Bariatric (BARI)	> 272 kg (> 600 lb)

Some slings may incorporate a colored liner in addition to the size label. The color code is as follows:

- XS: White
- S: Red
- M: Yellow
- L: Green
- XL: Blue
- XXL: Orange
- BARI: Dark grey

5. USING THE DEVICE



WARNING

Read the *Safety Instructions* in this manual **BEFORE** using the device.

The device must **NEVER** be operated by the person being transferred. In the unlikely case of failure, the patient could get stuck in the unit.

Before Transfer

- Ensure the ceiling lift battery is charged.
- Ensure the track end stops are securely in place as shown below.

Figure 6



- Inform the person to be transferred what you are about to do.
- Always evaluate the person's general condition before transfer.
- Ensure you have a sling that is the correct size for the person. Use only slings that are designed for use with the ceiling lift.

Transferring the Person

- 1 Place the person to be transferred into the sling as described on the following pages or per the documentation provided with the sling.
- 2 To turn on power to the ceiling lift, push the *On/Off Switch* (red plunger). If it's out of reach, you can use a broom handle (or something similar) to push the plunger.

Figure 7



NOTE

To turn off power to the ceiling lift, pull down on the red cord, the red plunger will be as shown below. Note that the red cord can also serve as an Emergency Stop.

**WARNING**

Ensure you can reach the emergency cord before using the ceiling lift. This warning applies especially when the ceiling lift is installed in a track above 2.75 m (9 ft) while the operator height is under 152 cm (5 ft).

The red cord can be extended; contact your Savaria dealer for more information.

Figure 8



- 3 Lower the carry bar by pressing the DOWN button on the hand control or touchpad membrane while maintaining tension on the carry bar with your other hand. Note that there must be tension on the ceiling lift strap for the device to function.

**CAUTION**

We recommend that you grab the carry bar to avoid unexpected movement or impact with the patient that may cause injuries.

- 4 Verify that the carry bar is well attached to the strap by the presence of the locking ring.

Figure 9

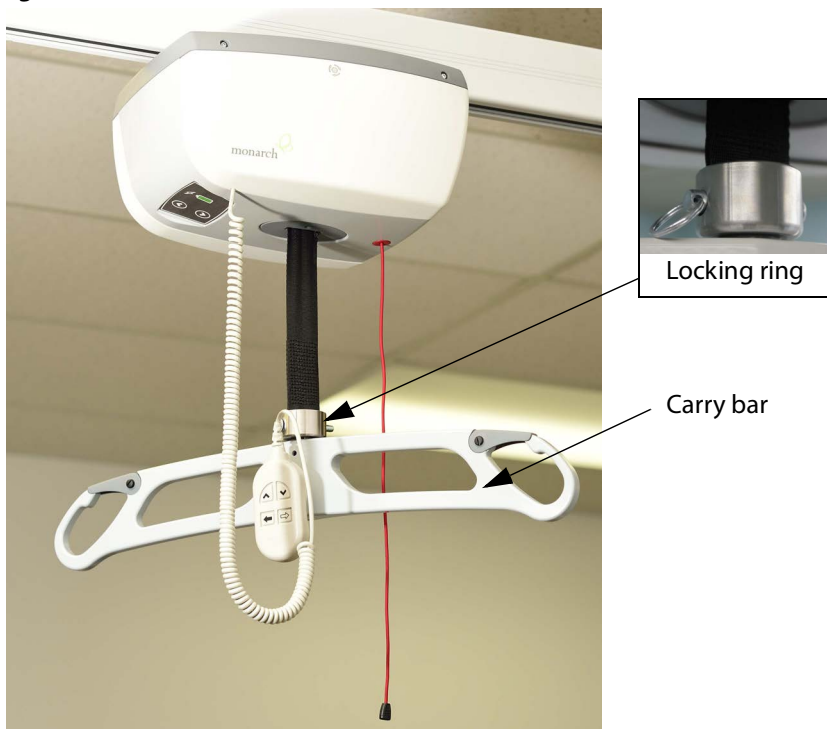

- 5 Move the ceiling lift over the person to be transferred by pressing the LEFT or RIGHT lateral arrow buttons on the hand control. If the ceiling lift doesn't have a motorized trolley, drag the ceiling lift along the track using the carry bar.

CAUTION

**Do NOT move the ceiling lift by pulling the hand control.
The handset may spring return and cause injuries.**

- 6 Press the DOWN button on the hand control or touchpad membrane to lower the carry bar above the head (4-point carry bar) or below the chin (2-point carry bar). You need to unfold the sling straps before attaching them to the carry bar hooks. Note that there are different loops on the sling straps (as shown in the following figures) to allow transfer from the sitting or reclined position.

NOTE

Different types of slings are available. Your sling may differ from the one shown below, but the following basic concepts still apply.

- To transfer to/from the fully seated position (as shown in the following figures), use the short loops at the back and the long loops at the front.
- To transfer to/from the fully reclined position (as shown in the following figures), use the long loops at the back and the short loops at the front.
- Note that the middle loops are used for intermediate positions..

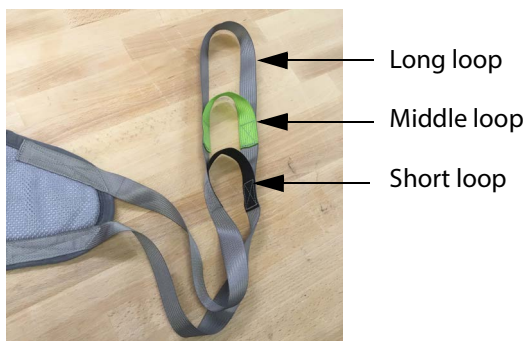
Figure 10

Fully seated position



Fully reclined position



- 7 Some slings are equipped with an adjustable head support feature consisting of two adjustable straps. Tighten the straps as needed for full head support and release them for less support as shown below.

Figure 11



Straps tightened (full support)



Straps released



- 8** The photos below show the two methods that can be used for the leg straps of the sling (regular or crossed).

Figure 12



Leg straps
regular position

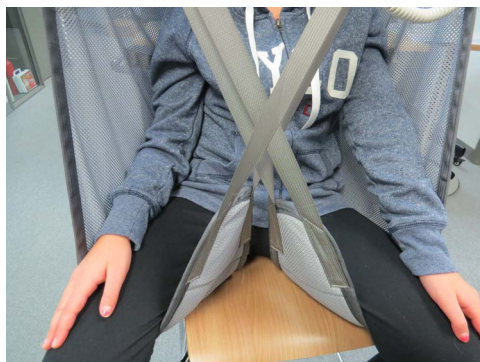

Leg straps
crossed position

- 9 If using the hygienic sling, install the sling on the chest near the underarm to maximize comfort and stability during transfer (see the photo below). The second photo below illustrates the position for transfer using the hygienic sling.

Figure 13



Installing the
hygienic sling



Position for transfer
using hygienic sling

10 If using the walking sling, install the sling on the chest near the underarm to maximize comfort and stability during transfer (see the photos below). The bottom photo below illustrates the position for transfer using the walking sling.

Figure 14

Installing the walking sling



Position for transfer
using walking sling

- 11 Note that the safety latches are spring-loaded and will close automatically.
- 12 Lift up on the safety latch with one hand and slide the sling loop onto the carry bar hook with your other hand. The safety latch will spring closed, trapping the sling loop inside the carry bar hook. **The safety latch must be completely closed as shown below.**

Figure 15

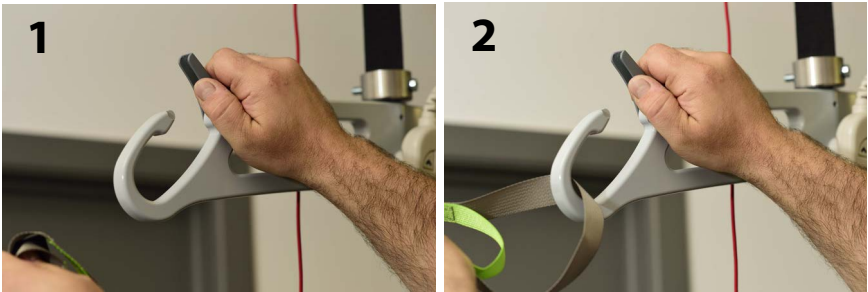

All safety latch must be completely closed as shown.

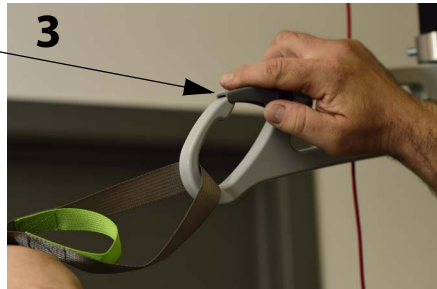

DANGER

Do NOT attempt a transfer if the safety latches are not completely closed. The sling loops MUST be trapped inside the carry bar hooks to prevent the person from falling and sustaining possible injuries.

- 13** Before lifting the person, ensure the sling loops are securely locked in the carry bar hooks and the person is comfortable. Make sure the sling is not caught on any obstruction.

**WARNING**

NEVER leave a person unattended during a transfer to prevent the person from falling and sustaining possible injuries.

- 14** To lift the person, press the UP button on the hand control or the touchpad membrane. Note that you can use the handles on the sling to help with guiding the person.

Figure 16



Use handles on sling to help with guiding

- 15** Before moving the person, ensure the person/the sling clears the arms of the wheelchair, or the top of the bed. Guide their legs past any obstacles. Note that there is no need to raise the person far above any obstacles, just enough to clear them.
- 16** When the person is above the desired point of transfer, press the DOWN button on the hand control or touchpad membrane to lower the person.

- 17** Once the person is properly seated and there is no more tension in the sling straps, disengage the sling from the carry bar hooks. To do this, lift up on the safety latch containing the sling loop (as shown below) and slide the strap off.

Figure 17



WARNING

Before moving the ceiling lift away from the person ensure that all sling straps are no longer trapped in the carry bar hooks. This will prevent the patient from rolling off the sling and sustaining possible injuries.

- 18** Move the ceiling lift away from the person. Use the hand control or touchpad membrane to shorten the strap. You can now remove the sling from around the person who was transferred.
- 19** Move the ceiling lift under the charging station to ensure the battery is charged for the next use. If the ceiling lift and track are equipped with the constant charging system (CCR), there is no need to place the ceiling lift in a specific place as the device will recharge anywhere along the track.

NOTE

The ceiling lift will not charge if the red Emergency Stop cord is pulled.

Emergency Lowering



Use the emergency lowering feature for emergency only.

The ceiling lift is equipped with an emergency lowering device that allows you to lower the strap if the electrical system is not functioning. The emergency lowering device is activated using a standard 6mm Allen key (supplied with the device).

- 1 Pull the emergency stop cord to turn off the ceiling lift.
- 2 Move the person in the ceiling lift over the wheelchair or bed.
- 3 Using the Allen key, puncture the label to access the emergency lowering mechanism.
- 4 Turn as indicated on the punctured label to lower the person. Note that each turn of the key will lower the person slightly. Once the person is lowered safely into the wheelchair or bed, remove the Allen key from the access opening.
- 5 Call your Authorized Savaria Dealer to service the device.

Figure 18

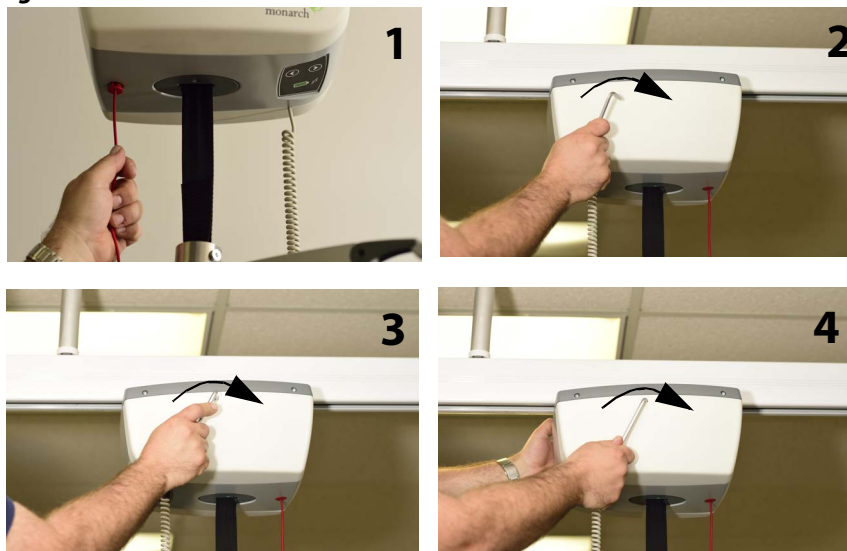

Some models do have the emergency lowering system located on another side of the enclosure and require a 4mm Allen key (provided with the ceiling lift).



Emergency Brake

The emergency safety brake is an additional safety feature that automatically prevents the person from falling in the event of a transmission or motor failure.



If the emergency brake has activated, do NOT attempt to unlock the brake or press the UP button as this may disengage the brake and cause the person in the ceiling lift to fall. Do NOT attempt to use the emergency lowering device either as injuries could occur.

Switch off the device and make sure there is no more use of the ceiling lift. Contact your Authorized Savaria Dealer to carry out an inspection.

Charging the Battery

NOTE

If the battery level is very low and you press a button, you will hear a beep and see the battery LED indicator blinking on the ceiling lift. The beeping sound and blinking LED will stop when the button is released. Charge the battery as soon as possible.



WARNING

Use ONLY the charger #M920001 provided with the ceiling lift. Using any other charger may result in permanent damage to the batteries or cause fire, explosion, or injuries.

Do NOT operate the battery charger with a damaged cord or damaged charger enclosure as this may cause fire or electrical shock.

- 1 Ensure the charger is plugged into the AC wall outlet. The green indicator on the charger will come on solid.
- 2 Move the ceiling lift under the charging station.
- 3 The charging indicator on the ceiling lift is solid yellow when the battery is charging.
- 4 If the battery is low, it will take approximately 2 hours for a full charge. Charge the battery fully before using the ceiling lift again.

Move the ceiling lift under the charging station when it is not in use to ensure the device will be fully charged for the next use. The device can be charged for an extended period of time without damaging either the charger or the battery.

For a ceiling lift and track equipped with the constant charging system (CCR), there is no need to place the device in a specific place as it will recharge anywhere along the track.

The device should not remain stored for long periods of time without charging the battery. Charge the battery at least every month to maximize the life span.

NOTE

The ceiling lift must be in the "ON" position to charge the battery. If the red Emergency Stop cord is pulled, the ceiling lift will not charge.

When the battery is charging, the lightning bolt symbol on the touchpad membrane will be solid yellow.

Figure 19

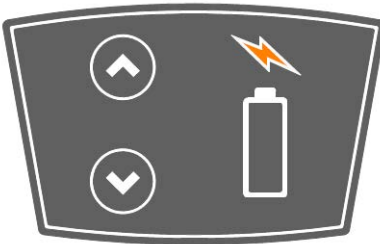

When the battery is fully charged, the lightning bolt symbol will turn off and the green full battery symbol will come on.

Figure 20

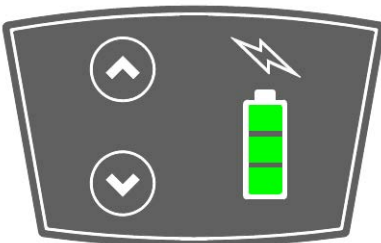

6. MAINTENANCE

The device is subject to wear and tear from use. You must perform the checks and actions in the following tables to ensure safety and proper operation.



WARNING

Contact your Authorized Savaria Dealer to perform the Dealer Checks/Actions. Safety-related maintenance and service must be performed by an Authorized Savaria Dealer as these shall be carried out by demonstrably competent and specifically trained people, familiar with the design, use and care of the device.

This maintenance schedules provides the minimum recommendations. In some cases, more frequent checks may be required per local regulations and codes.

To ensure safety of the person being transferred and the operator, do NOT use the equipment if a fault is found or if these regular checks have not been performed.

Environmental Notice

For disposal of any components associated with the product, have them separated and recycled according to the WEEE directive. Contact appropriate local authorities for more information.

Operator Maintenance Schedule

Perform the following checks/actions as indicated. If any of the checks fail, contact your Authorized Savaria Dealer for service or replacement of parts.

Operator Check/Action	Frequency
Charge the battery	Before every use
Check the device strap for wear	Before every use
Check the sling and the sling straps for wear	Before every use
Check that there are no flaws or signs of fraying in the stitched areas of the sling	Before every use
Check the carry bar for any damage. Carry bar pivot must be free of deposit and must move freely (rotation & up/down movement).	Before every use
Check the operation of the hand control buttons	Before every use
Check the track and hardware for any damage	Before every use
Check the track end stops are securely in place	Before every use
Check the ceiling lift moves freely along the track	Before every use
Clean the outside of the device	As required
Check the operation of the device control buttons	Every 4 months
Clean the track	Every 4 months
Check the emergency stop function (by pulling the emergency stop cord). Confirm that the device is powered off and the remote control is inoperative.	Every 4 months
Check the ceiling lift casing for any damage	Every year
Check the track, hardware, and trolley wheels for damage	Every year

Dealer Maintenance Schedule

Perform the checks/actions listed in the Operator Maintenance Schedule as well as those listed in the table below.

Dealer Check/Action	Frequency
Check the ceiling lift casing for any damage	Every year
Check the ceiling lift transmission	Every year
Check the ceiling lift connecting joints	Every year
Check that the emergency brake is turning freely	Every year
Check that all emergency devices are working properly	Every year
Perform a load test on the ceiling lift and track system with the Safe Working Load	Every year
Replace the ceiling lift strap	Every 2 years
Lubricate the roller and the spool shaft	Every 2 years
Lubricate the transmission spool gear	Every 2 years



WARNING

To avoid potential injury, use ONLY Savaria parts when replacing parts.

To prevent the person from falling (or objects from falling) that may cause injuries to the person, the operator or other persons, always reinstall the track end stops if they were removed for servicing. Note that the recommended tightening torque is 20 N-m (15 lb-ft).

Figure 21



Inspection and Cleaning

To clean the device, wipe down the casing with a damp cloth using warm water and a cleaner. Follow with a clean damp cloth to remove excess cleaner. Finish with a dry cloth to remove excess moisture. You can also use wipes that have a 70% v/v solution of isopropyl alcohol.

Rub the device vigorously with the cloth or wipe to ensure thorough cleaning of the entire surface.



WARNING

Do not use phenol, chlorine or any other type of solvent that may cause the device deterioration resulting in load bearing component failure.



WARNING





Do not splash, drench or immerse the unit in water as the unit could malfunction causing injuries to occur.

To ensure a better rolling surface for the trolley wheels, clean the inside of the track every 4 months. To do this, insert a damp cloth in the opening and slide it from one end of the track to the other.

Cleaning the Sling

Clean the sling according to the symbols on the label (see below).

Wash at a temperature up to the one indicated on the label, do not iron, do not use bleach and do not tumble dry; air drying is recommended.

	Wash normally at a temperature up to the one indicated on the label. Washing at a higher temperature may affect and reduce the mechanical resistance of the sling. Cold or lukewarm water washing is recommended.
	Do not iron as it may affect and reduce the mechanical resistance of the sling.
	Do not use a bleach agent. Bleach may affect and reduce the mechanical resistance of the sling.
	Do not tumble dry the sling. Tumble drying may cause excessive twist, tear and wear of the sling that may affect and reduce the mechanical resistance of the sling. Air drying is recommended.

7. TROUBLESHOOTING



WARNING

Do NOT open the device casing. Only an Authorized Savaria Dealer is qualified to open it. Modifications made to the device by someone other than a qualified technician may cause serious injury.

Problem	Action
The unit starts and stops repeatedly.	If the load is greater than the Safe Working Load of the device, it will not function due to an overload on the motor.
The ceiling lift emits a beeping sound during use. The device may stop lifting the person but can still lower the person.	The battery is low and needs to be charged.
Yellow lightning charging indicator on the ceiling lift does not light up when the charger is connected to the device.	Ensure the charger is plugged into a standard electrical outlet and that the outlet has power. The green LED on the charger will be turned on. Note that the battery may have sufficient power and does not need recharging. The charger automatically detects if charging is required or not.
The device does not move when you press a button on the touchpad membrane or on the hand control.	Make sure the On/Off power switch on the ceiling lift is turned On. Check that the battery is charged. Reset the device by turning the switch off for a few seconds and then back on. Wait a few moments and see the status of the device (battery LED indicator). If the problem persists and the ceiling lift still does not operate, contact your Authorized Savaria Dealer for service

8. ELECTROMAGNETIC COMPATIBILITY

Electromagnetic Compliance

The device has been tested for compliance with current regulatory standards in regards to EMI (electromagnetic interference).



WARNING

Use of this equipment adjacent to or stacked with other equipment should be avoided because it could result in improper operation. If such use is necessary, this equipment and the other equipment should be observed to verify that they are operating normally.

Use of accessories and cables other than those specified or provided by the manufacturer of this equipment, could result in increased electromagnetic emissions or decreased electromagnetic immunity of this equipment, and result in improper operation.

Portable RF communications equipment (including peripherals such as antenna cables and external antennas) should be used no closer than 30 cm (12 inches) to any part of the device, including cables specified by the manufacturer. Otherwise, degradation of the performance of this equipment could result.

Guidance and Manufacturer's Declaration - Electromagnetic Emissions - For All Equipment and Systems		
The device is intended for use in the electromagnetic environment specified below.		
Emissions test	Compliance	Electromagnetic environment - guidance
RF emissions CISPR 11	Group 1	The device uses RF energy only for its internal function. Therefore, its RF emissions are very low and are not likely to cause any interference with nearby equipment.
RF emissions CISPR 11	Class B	The device is suitable for use in all establishments, including domestic establishments and those directly connected to the public low-voltage power supply network supplying buildings used for domestic purposes.
Harmonic emissions IEC 61000-3-2	Not applicable	
Voltage fluctuations/ flicker emissions IEC 61000-3-3	Not applicable	

Electromagnetic Immunity

Guidance and Manufacturer's Declaration - Electromagnetic Immunity - For All Equipment and Systems			
The device is intended for use in the electromagnetic environment specified below.			
Immunity test	IEC 60601 test level	Compliance level	Electromagnetic environment - guidance
Electrostatic discharge (ESD) IEC 61000-4-2	+/-8 kV contact +/-15 kV air	+/-8 kV contact +/-15 kV air	Floors should be wood, concrete or ceramic tile. If floors are covered with synthetic material, the relative humidity should be at least 30%.
Surge IEC 61000-4-5	+/-1 kV differential mode +/-2 kV for common mode	+/-1 kV differential mode +/-2 kV for common mode	Mains power quality should be that of a typical commercial or hospital environment.
Power frequency (50/60 Hz) magnetic field IEC 61000-4-8	30 A/m	30 A/m	Power frequency magnetic fields should be at levels characteristic of a typical location in a typical commercial or hospital environment.
NOTE: <i>UT</i> is the AC mains voltage prior to application of the test level.			

Electromagnetic Immunity (continued)

Guidance and Manufacturer's Declaration - Electromagnetic Immunity - For All Equipment and Systems			
The device is intended for use in the electromagnetic environment specified below.			
Immunity test	IEC 60601 test level	Compliance level	Electromagnetic environment - guidance
Radiated RF IEC 61000-4-3	10 V/m 80 MHz to 2.5 GHz, 1Khz, 80% AM Mod.	10 V/m 80 MHz to 2.5 GHz, 1Khz, 80% AM Mod.	<p>Portable and mobile RF communications equipment should be used no closer to any part of the device, including cables, than the recommended separation distance calculated from the equation applicable to the frequency of the transmitter. Recommended separation distance:</p> $d = \left[\frac{3.5}{3} \right] \sqrt{P}$ $d = \left[\frac{3.5}{10} \right] \sqrt{P} \quad \begin{array}{l} 80 \text{ MHz to} \\ 800 \text{ MHz} \end{array}$ $d = \left[\frac{7}{10} \right] \sqrt{P} \quad \begin{array}{l} 800 \text{ MHz to} \\ 2.5 \text{ GHz} \end{array}$ <p>where P is the maximum output power rating of the transmitter in watts (W) according to the transmitter manufacturer and d is the recommended separation distance in metres.</p> <p>Field strengths from fixed RF transmitters, as determined by an electromagnetic site survey,^(a) should be less than the compliance level in each frequency range.^(b)</p> <p>Interference may occur in the vicinity of equipment marked with the following symbol:</p> 

Electromagnetic Immunity (continued)

NOTE 1: At 80 MHz and 800 MHz, the higher frequency applies.

NOTE 2: These guidelines may not apply in all situations. Electromagnetic propagation is affected by absorption and reflection from structures, objects and people.

(a) Field strengths from fixed transmitters, such as base stations for radio (cellular/cordless) telephones and land mobile radios, amateur radio, AM and FM broadcast and TV broadcast cannot be predicted theoretically with accuracy. To assess the electromagnetic environment due to fixed RF transmitters, an electromagnetic site survey should be considered. If the measured field strength in the location where the lift is used exceeds the applicable RF compliance level above, the lift should be observed to verify normal operation. If abnormal performance is observed, additional measures may be necessary, such as reorienting or relocating the lift.

(b) Over the frequency range 150 kHz to 80 MHz, field strengths should be less than 3 V/m.

Recommended Separation Distance Between - Portable and Mobile RF Communications Equipment and the device or Equipment and Systems that are not Life-Supporting

Recommended separation distances between portable and mobile RF communications equipment and the device.

The device is intended for use in electromagnetic environments in which radiated RF disturbances are controlled. The customer or the user of the device can help prevent electromagnetic interference by maintaining a minimum distance between portable and mobile RF communication equipment (transmitters) and the device as recommended below, according to the maximum output power of the communications equipment.

Rated maximum output power of transmitter W	Separation distances according to frequency of transmitter m		
	150 kHz to 80 MHz $d = \left[\frac{3.5}{3} \right] \sqrt{P}$	80 MHz to 800 MHz $d = \left[\frac{3.5}{10} \right] \sqrt{P}$	800 MHz to 2.5 GHz $d = \left[\frac{7}{10} \right] \sqrt{P}$
0.01	0.12	0.12	0.24
0.1	0.37	0.37	0.74
1	1.17	1.17	2.34
10	3.69	3.69	7.38
100	11.67	11.67	23.34

For transmitters rated at a maximum output power not listed above, the recommended separation distance d in metres (m) can be estimated using the equation applicable to the frequency of the transmitter, where P is the maximum output power rating of the transmitter in watts (W) according to the transmitter manufacturer.

NOTE 1: At 80 MHz and 800 MHz, the separation distance for the higher frequency range applies.

NOTE 2: These guidelines may not apply in all situations. Electromagnetic propagation is affected by absorption and reflection from structures, objects and people.

THIS PAGE WAS INTENTIONALLY LEFT BLANK

THIS PAGE WAS INTENTIONALLY LEFT BLANK

THIS PAGE WAS INTENTIONALLY LEFT BLANK

Authorized Savaria Dealer

Savaria

Fixed Ceiling Lift

OWNER'S MANUAL

Part No. 001108-EN
Rev. 007 10-m10-2023
© Copyright 2023

Savaria Concord Lifts, Inc.
2 Walker Drive
Brampton, Ontario, L6T 5E1, Canada
www.savaria.com

For service or questions about this product, please contact your installing dealer.

DEALER NAME: _____

DEALER PHONE: _____

